



# SPIRE Spectrometer Data: Calibration Updates, User Data Reprocessing, and Other Issues

Nanyao Lu

NHSC/IPAC

(On behalf of the SPIRE ICC)





# Outline

- Calibration updates.
- User data reprocessing.
- Issues that may impact your data and how to deal with them:
  - Continuum offset
  - Fringe problem?
  - Partially resolved lines
  - Semi-extended sources, pointing offset
  - Cooler cycles
  - LR mode



## Why Might You Want to Reprocess Your FTS Observations?

### Two Main Reasons:

- Both calibration and pipeline are still being improved at this point. You might want to process your data with the latest calibration files (i.e., spire\_cal\_11\_0).
- Depending on your particular observation, you may want to explore possible improvements to the standard data reduction pipeline, especially if your targets are faint (i.e., of a few Jy). We discuss a few “issues” that may affect your observations, and how you can deal with them.



# HIPE 11: Reduced Noise & Finges

Mrk 231 50 Reps. OD 209

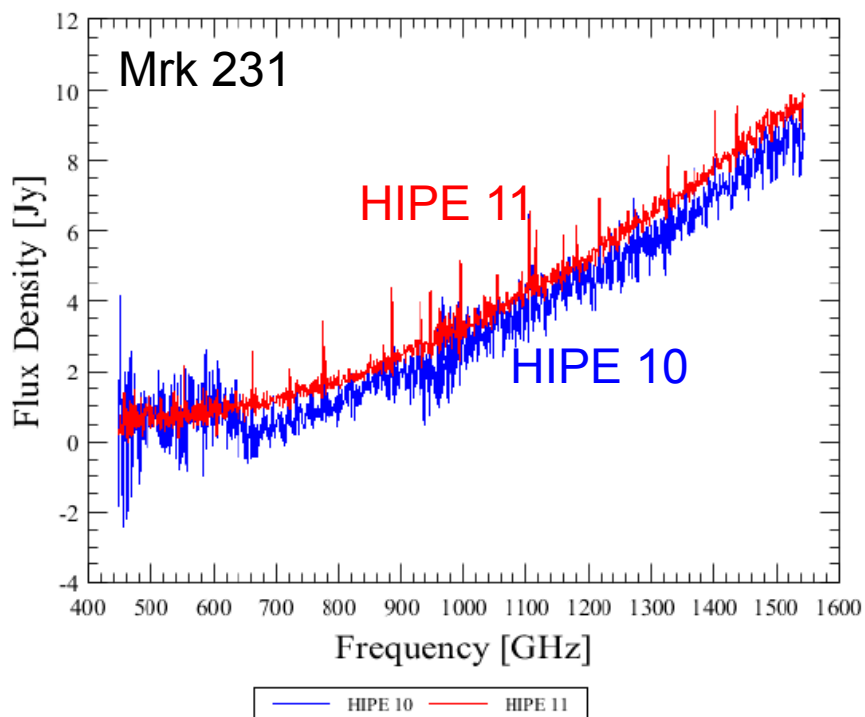

Dark Sky 50 Reps. OD 209

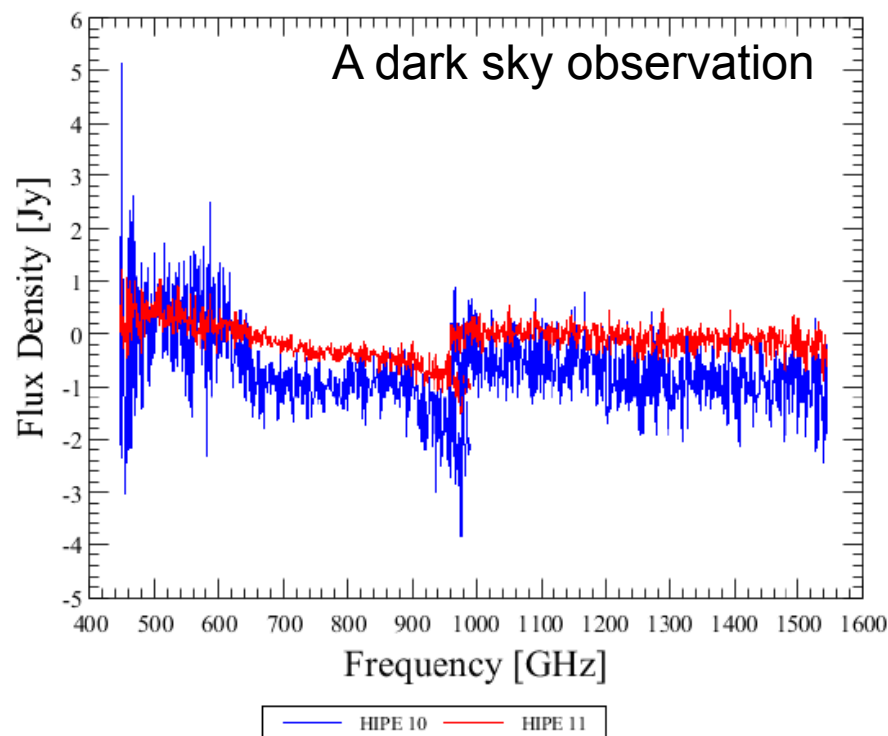



# HIPE 11: Better RSRFs → Better Sensitivity

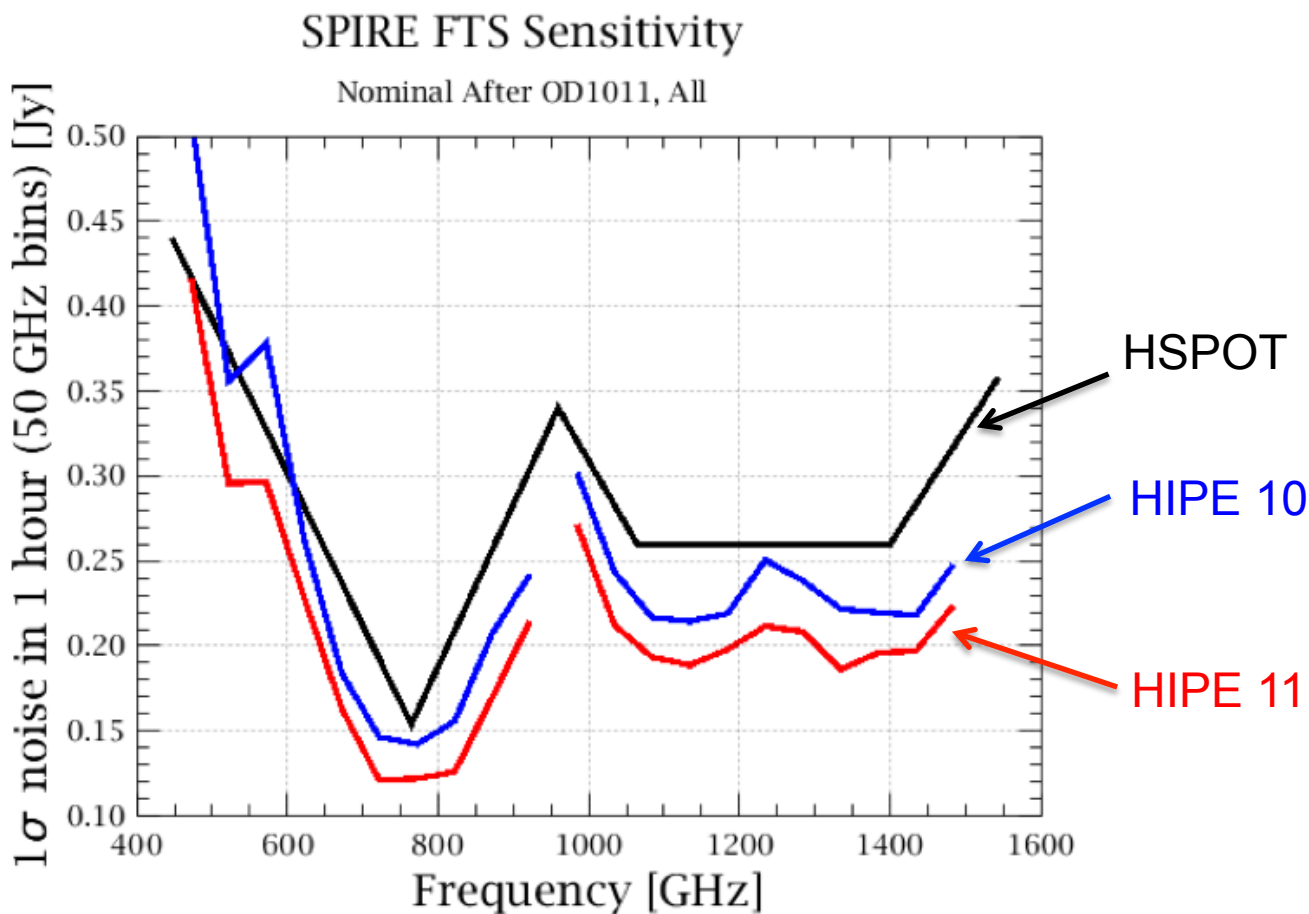



## HIPE 11: Much Better Results for the Bright Source Mode

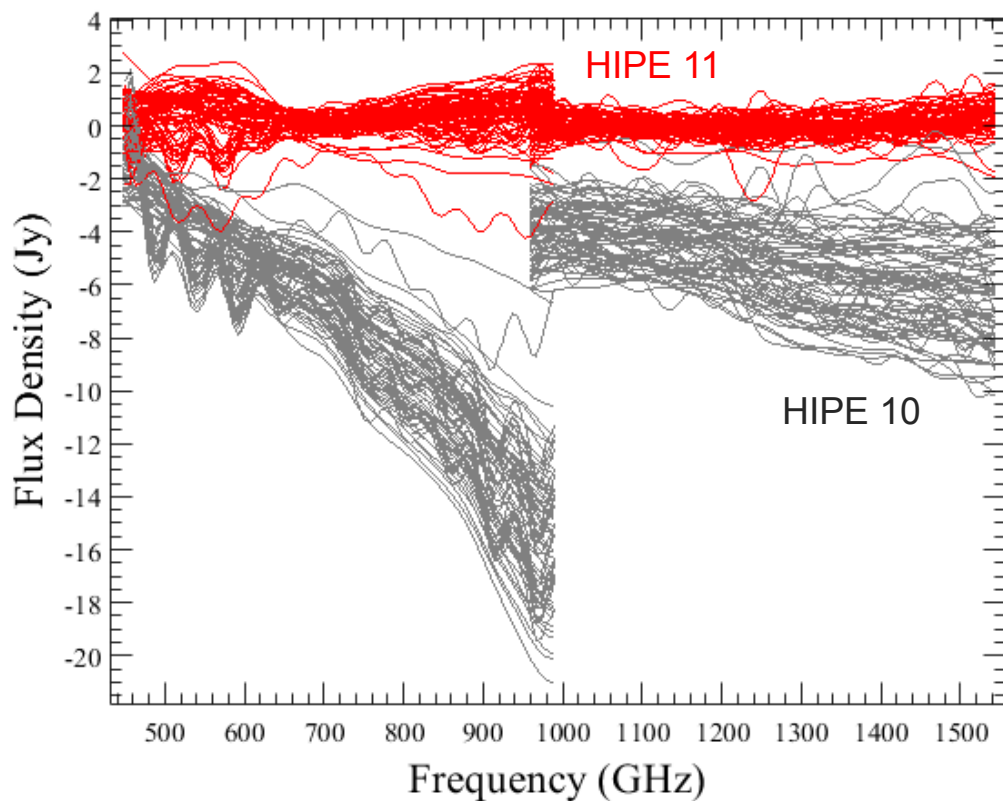

- HIPE 11 gives much better results on dark observations than HIPE 10.

NOTE: Ideally we want a flat spectrum at 0 Jy for these (telescope background-subtracted) spectra of dark sky.



## How to Do a User Data Reprocessing?

- You can load the spectrometer data reprocessing script within your HIPE session:
  - HIPE -> Pipelines -> SPIRE -> Spectrometer single pointing user pipeline.
- As an example, at the end of this session, I will show how to run this script to reprocess an observation from HIPE 10 to 11:
  - Obsid = 1342230419
  - Target = ESO099-G004
  - HR, 40 FTS repeats, sparse sampling, with nominal detector setting.

(Note: This is one of the sample observations for the workshop.)
- Then during the last SPIRE session this afternoon, you can do an exercise to compare the spectral noise between HIPE 10 and 11 results on this particular observation.



## Potential Issues

- Issues that may impact your data and how to deal with them:
  - I. Continuum offset.
  - II. Fringes, and how to remove them.
  - III. Partially resolved lines.
  - IV. Semi-extended sources (or pointing offset).
  - V. Impact from the cooler cycles.
  - VI. Long exposures in the LR mode.





# I. Continuum Flux Systematics

*Telescope Emission Dominates Most Observations!*

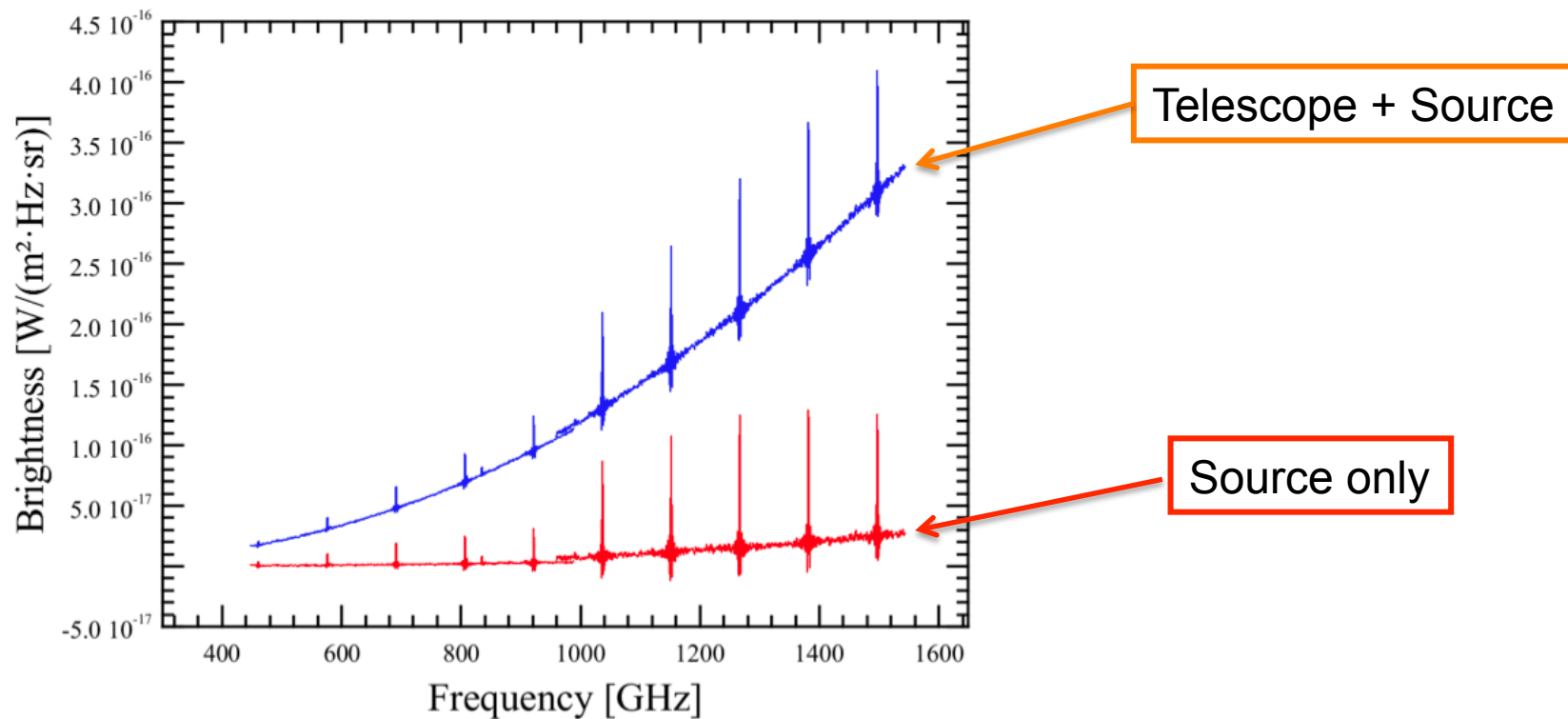



# Uncertainty from Telescope Emission Removal

Standard deviation of > 5000 dark sky scans reduced using the standard pipeline:

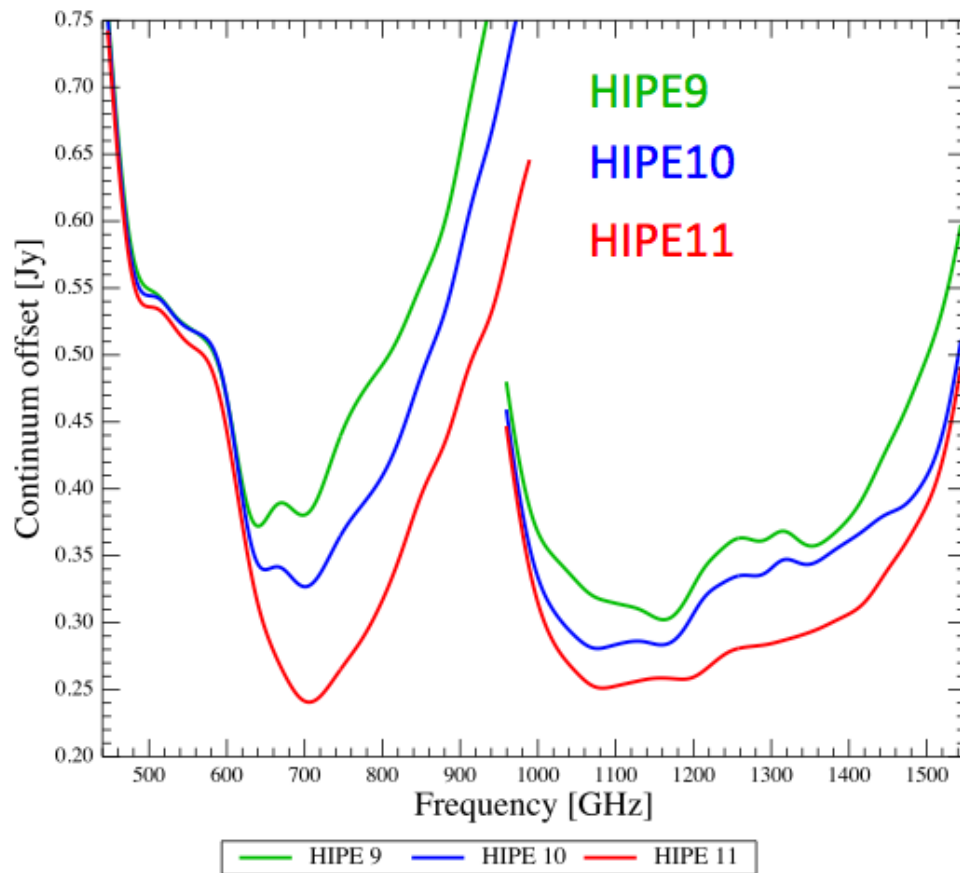

- Continuum flux calibration accuracy in HIPE 11 is on the order of  $\sim 0.3-0.6$  Jy for SLW and  $\sim 0.3-0.4$  Jy for SSW.
- Further improvement may be done using the background subtraction script.



## How to Remove Residual Telescope Emission?

- Two practical ways:
  - Subtract an observed **Dark Sky** from the same observational day, as close in time to your observation as possible, which is processed in the same way as your own observation.
    - A list of dark observations can be found at:  
<http://herschel.esac.esa.int/twiki/bin/view/Public/SpireDailyDarkObservations>
  - Subtract a **median spectrum** from surrounding detectors in case of a point source observation:
    - We will demo how to do this using a simple script in the end of the session.

A script for doing both these corrections is available inside HIPE:

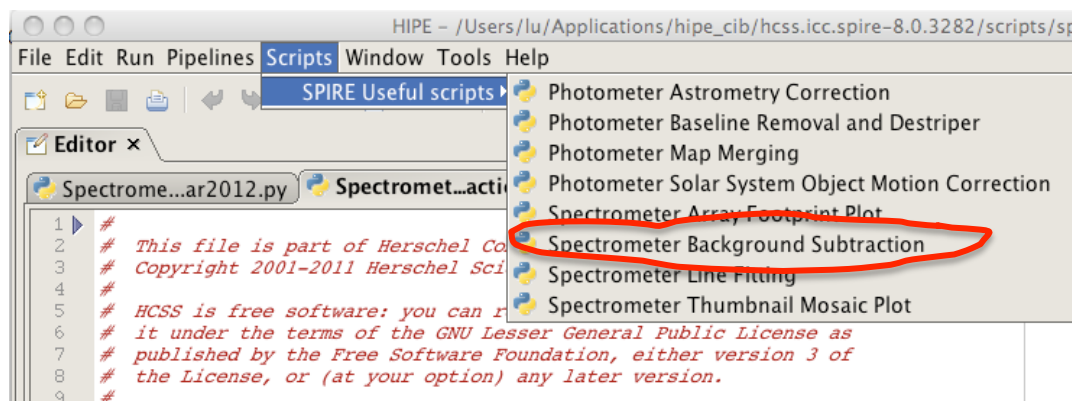



## Residual Telescope Emission Removal: Using Surrounding Channels

SSW

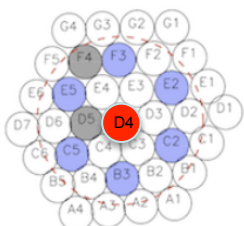

SLW

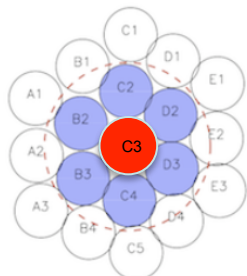

- Using a median spectrum from the **co-aligned detectors** as the residual telescope spectrum.
- This (or a polynomial fit to it) is then subtracted from the spectrum of the **central detectors**.

ESO099-G004: SSWD4 + SLWC3

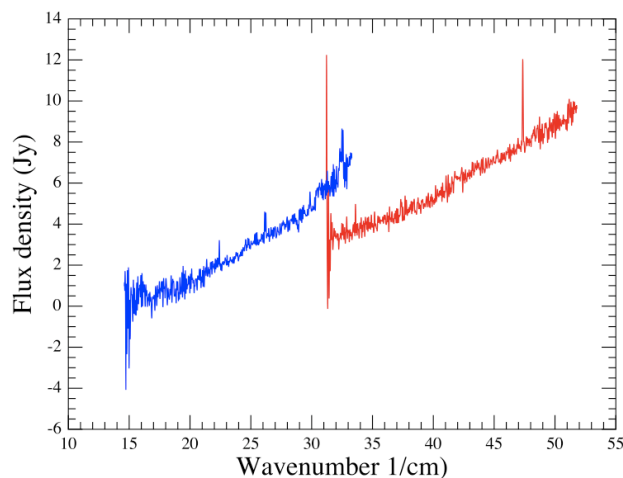

ESO099-G004: SSWD4 + SLWC3

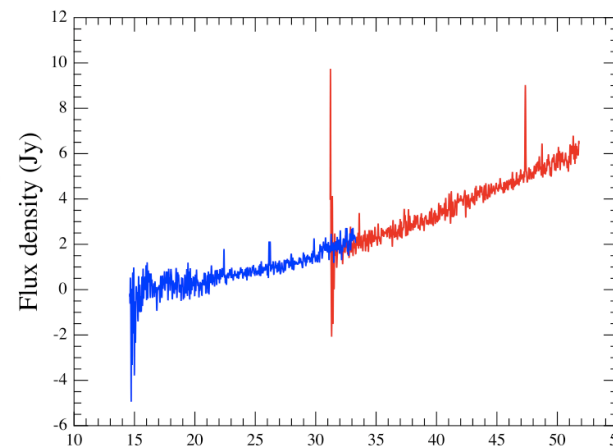



# Residual Telescope Emission Removal: More Examples

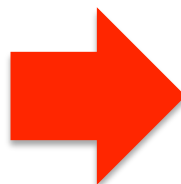
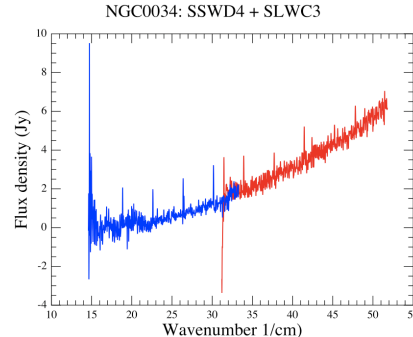
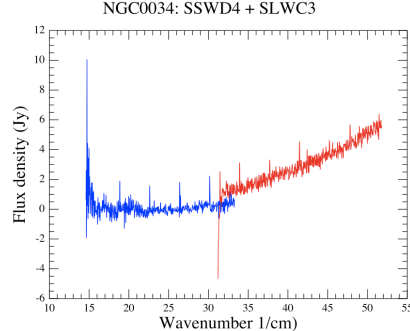
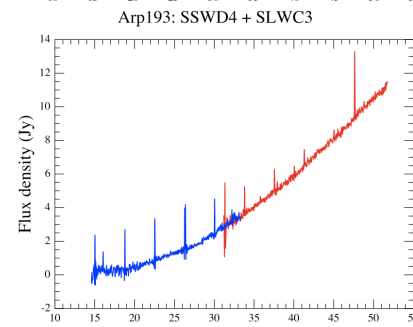
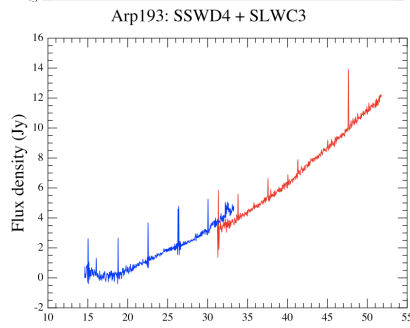
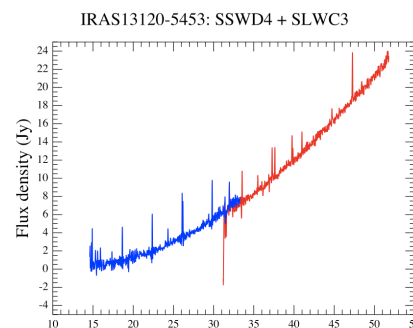
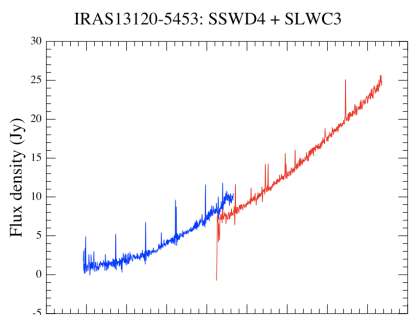

See a demo  
on this in this  
afternoon



# Systematic Noise Over the Mission (NOTE: HIPE 10 Results)

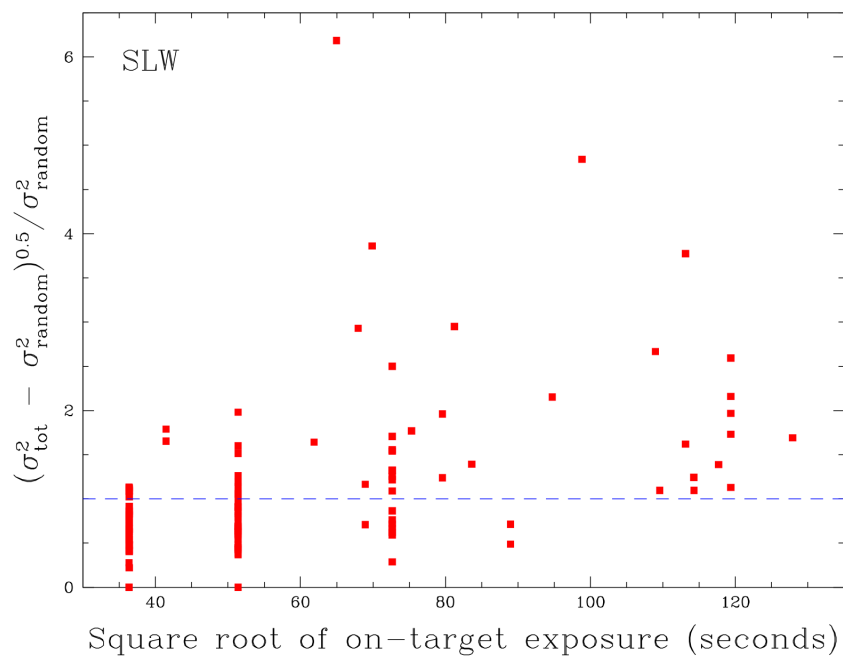
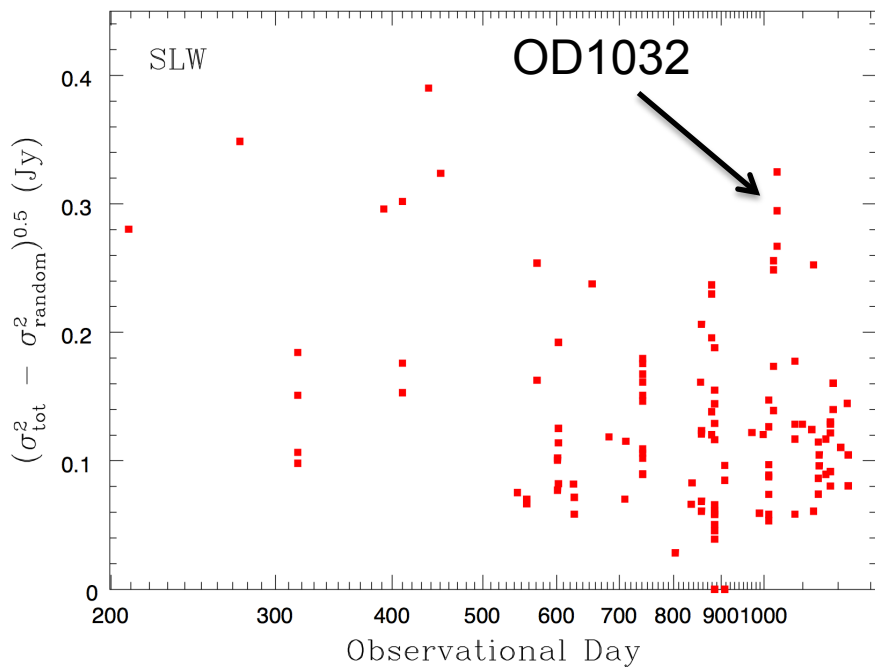



## II. Any Significant Systematic Noise?

HIPE 9.1.0 - /Users/lu/Projects/SPIRE/DP\_Workshop\_1

elines Scripts Window Tools Help

← SPIRE Useful scripts ▶

- ▶ Photometer Astrometry Correction
- ▶ Photometer Baseline Removal and Destriper
- ▶ Photometer Bolometer Finder
- ▶ Photometer Calculate Ephemeris SSO Position
- ▶ Photometer Map Merging
- ▶ Photometer Solar System Object Motion Correction
- ▶ Spectrometer Array Footprint Plot
- ▶ Spectrometer Background Subtraction
- ▶ Spectrometer Line Fitting
- ▶ Spectrometer Thumbnail Mosaic Plot
- ▶ Spectrometer Convolve Spectrum
- ▶ Spectrometer Noise Estimate

estimate.py x

```
#####  
#####  
script is set up to run  
HR'  
data == 'fromObsContext  
; = getObservation(myOb  
Set the Level-2 data fr  
;Level2 = obs.level2.ge
```

Script does a quick calculation of r.m.s. noise in your spectrum.



# Spectral Noise: An Example

(HIPE 10 result)

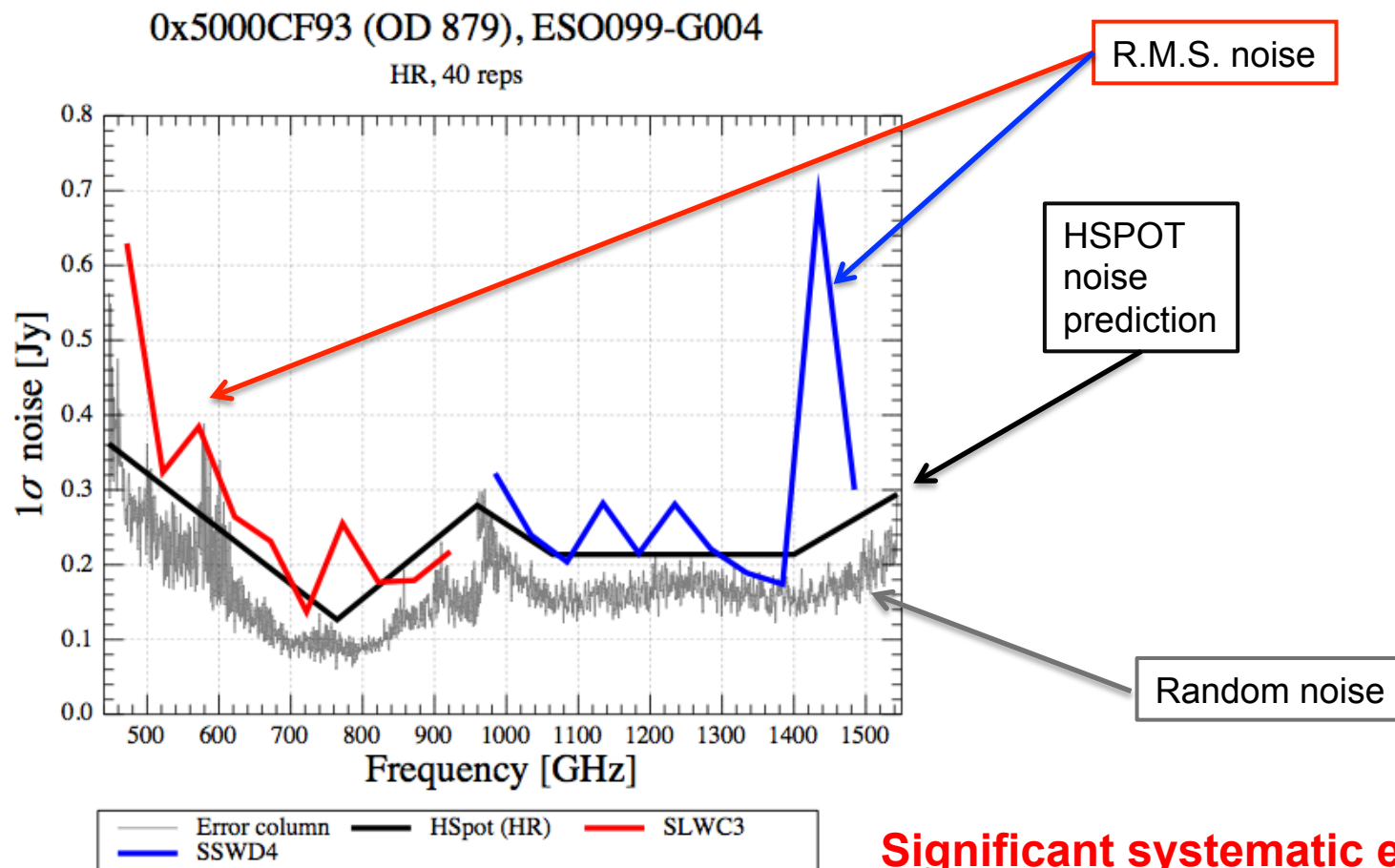





# Spectral Noise: An Example

(HIPE 11 result)

0x5000F27A (OD 1012), NGC1222

HR, 54 reps

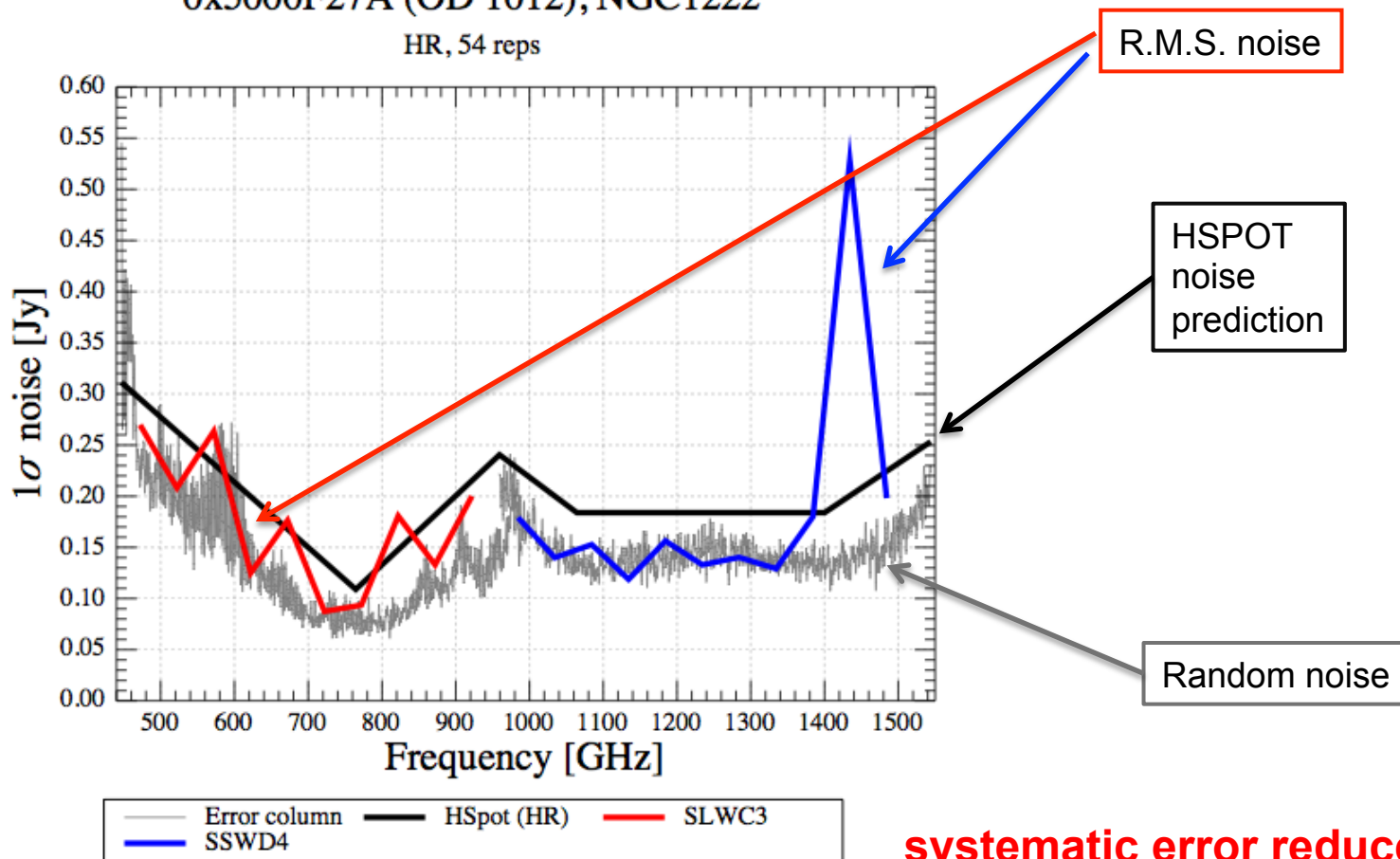



## How to Beat Down Systematic Noise

- *First and foremost, use or reprocess your data to HIPE 11 results.*
- If there is still significant systematic noise (or fringes), there are ways to reduce it:
  - **Direct dark subtraction:** Subtract from your observation a long dark observation taken in the same OD. (This may not work for early ODs, i.e., prior to OD1079, as dark observations were taken in a different mode, i.e., CR instead of HR.)
  - **Noise Template Method:** Create a correlated-noise template by median filtering observations of galaxies at different redshifts. Then this template spectrum could be subtracted from your own spectrum to remove much of the systematic noise. (This method always works. But you need to have access to other observations on the same OD.)
    - See [http://herschel.esac.esa.int/CalibrationWorkshop5/Posters/11\\_NanyaoLu.pdf](http://herschel.esac.esa.int/CalibrationWorkshop5/Posters/11_NanyaoLu.pdf)
    - A user script for this is available upon requesting.



### III. Spectral Resolving Power Depends on Wavelength

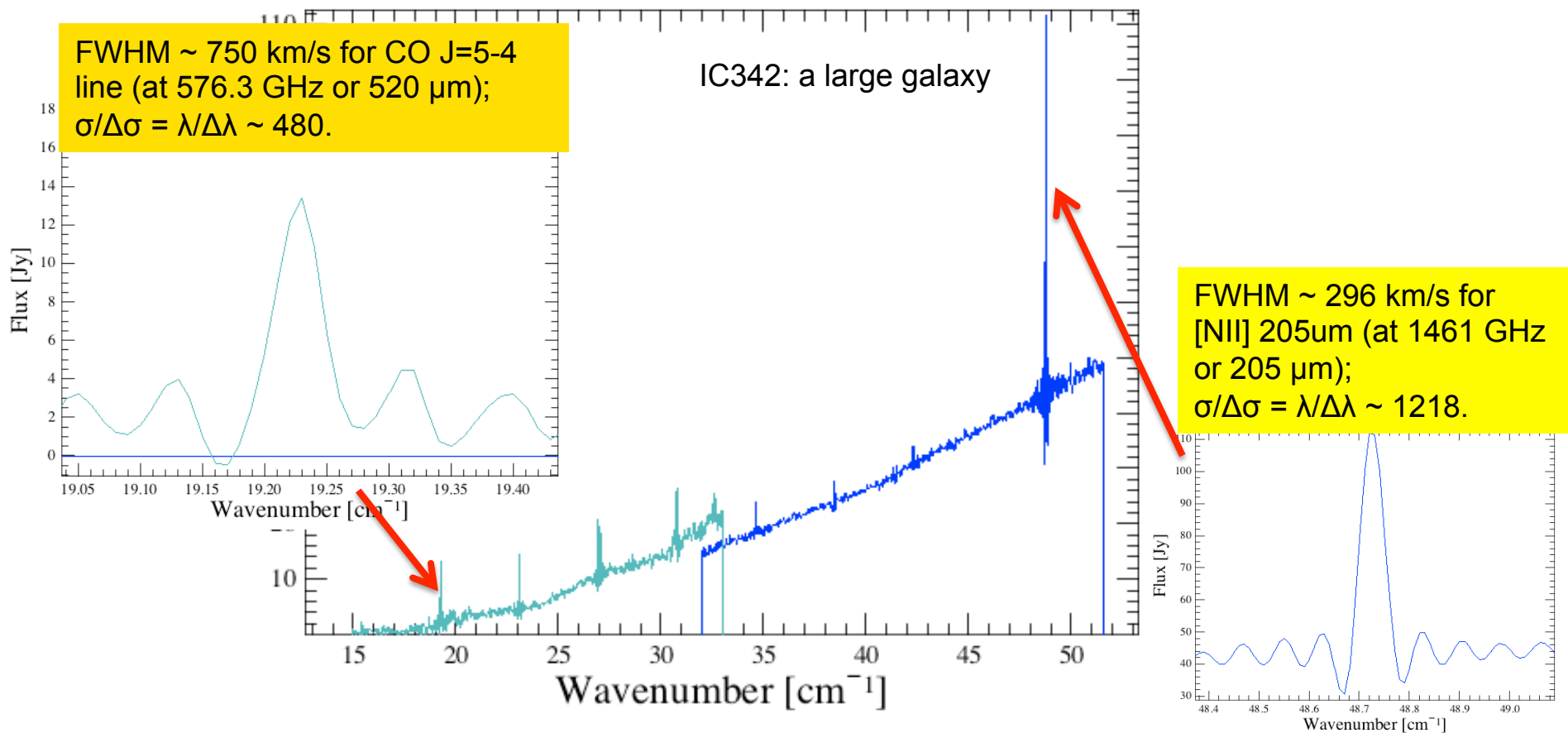



# [NII] 205 $\mu\text{m}$ Lines May be Partially Resolved

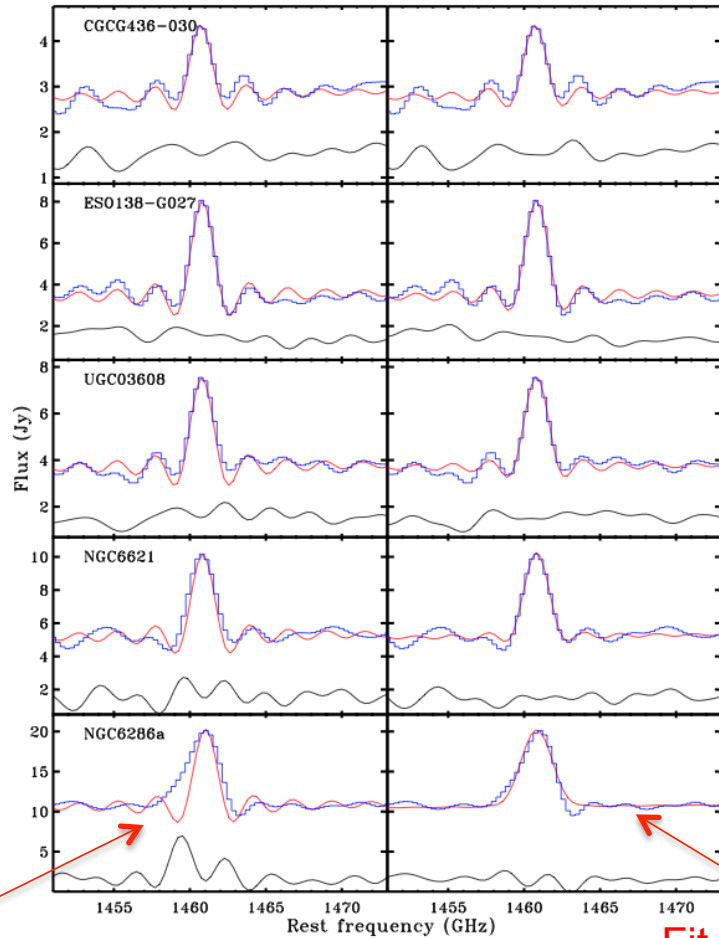

Fit with SINC only

Fit with SINC convolved with Gaussian (SincGauss model)

Flux Ratio (Gaussian convolved SINC to SINC only)

[NII] 205  $\mu\text{m}$   
 @1461 GHz

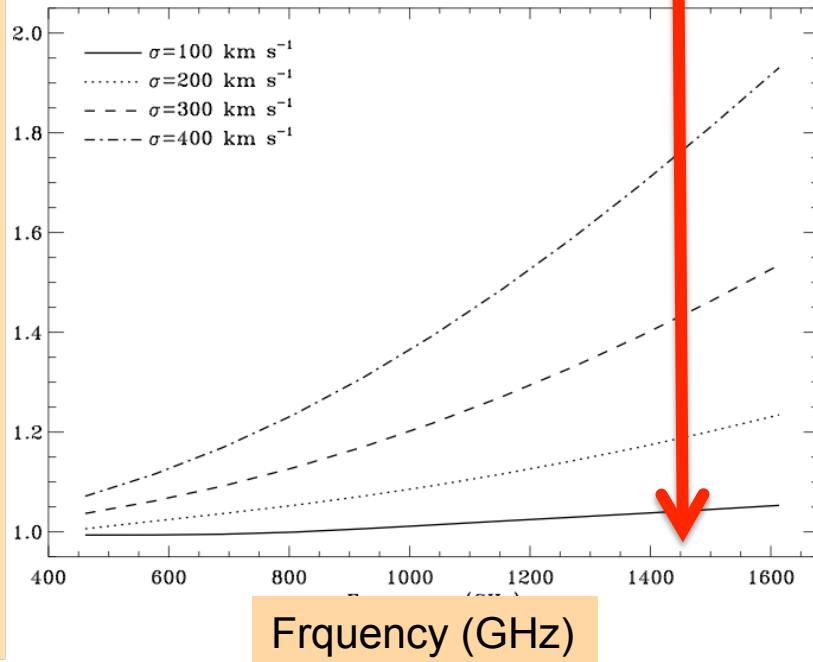



# Line Fitting with SincGauss Profile in HIPE

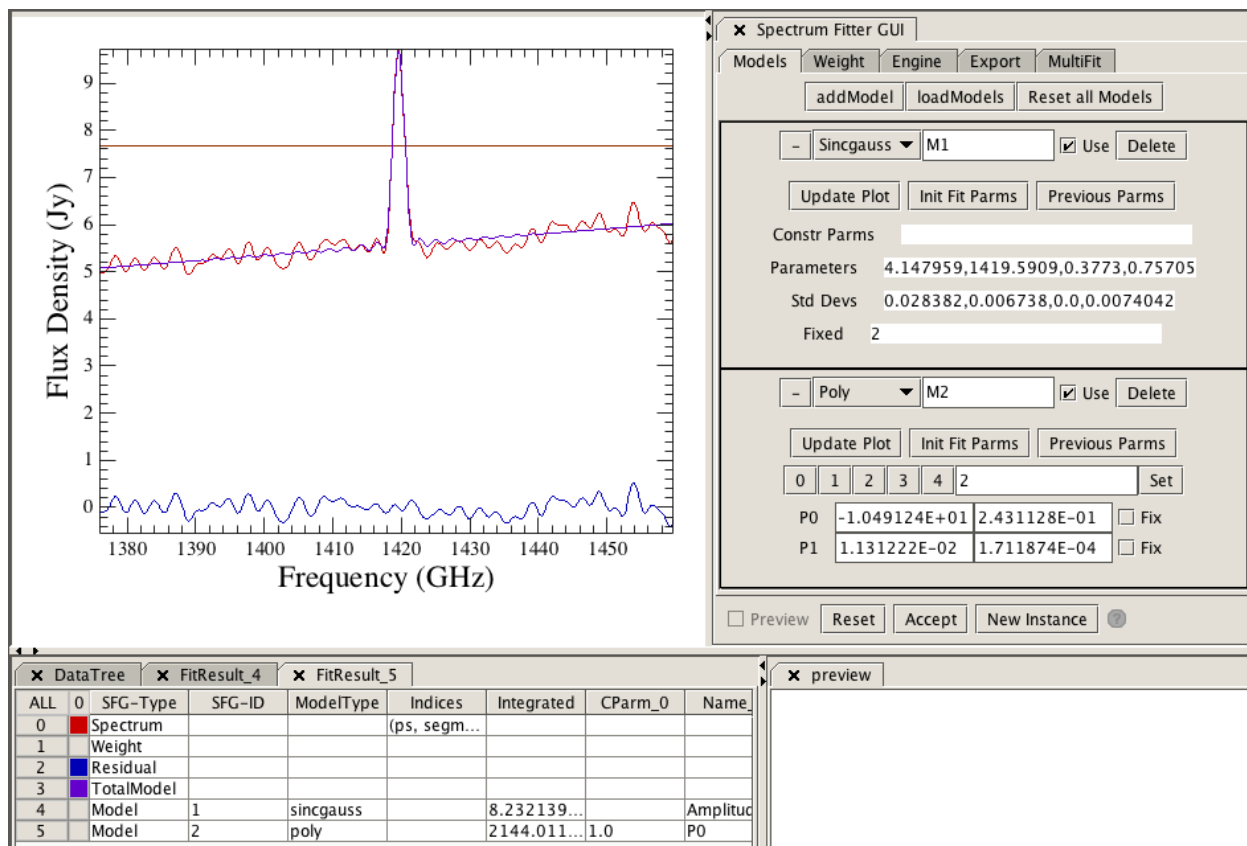

- Works best when S/N is high.
- For fainter lines, it might be better to use a SINC profile for fitting, and then correct the resulting flux for an estimated velocity width.
- See [SDRG, sect. 6.9.10](#) on how to use SincGauss line profile in script.

## IV. Semi-extended Source Correction Tool

Task name: **semiExtendedCorrector**

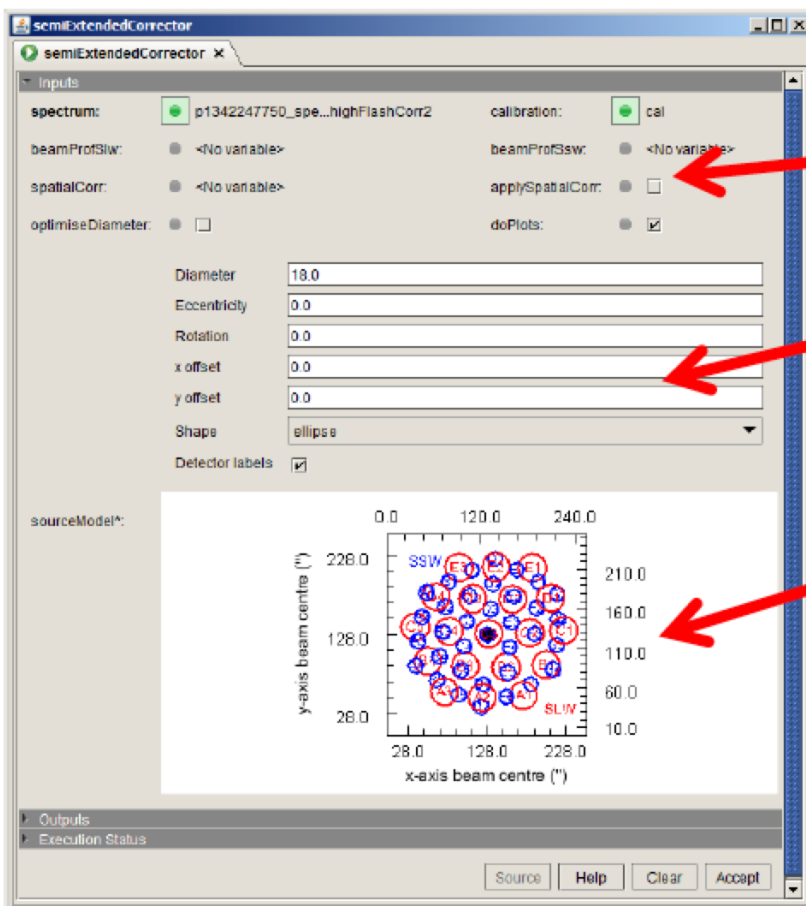

Input the Point-source calibrated Level-2 product and calibration tree

Enter the details of the source model

Source model visualised with footprint

Applicable to centre detectors:

Ellipse  
Gaussian

(For more information. see: Wu et al 2013 --- <http://arxiv.org/abs/1306.5780>)



# Semi-extended Source Correction Tool

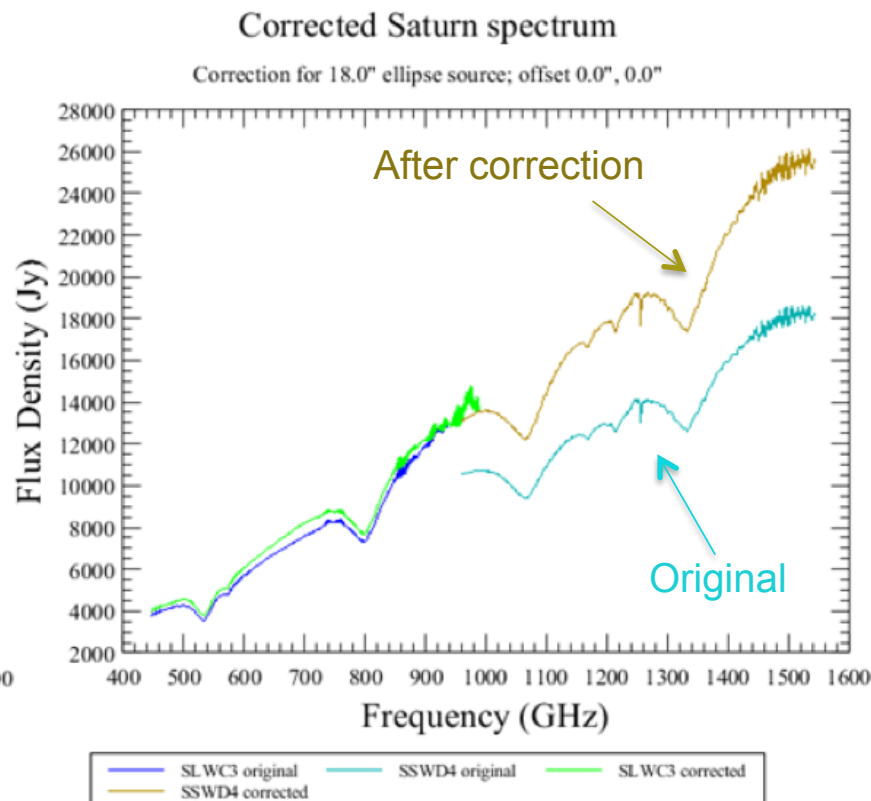
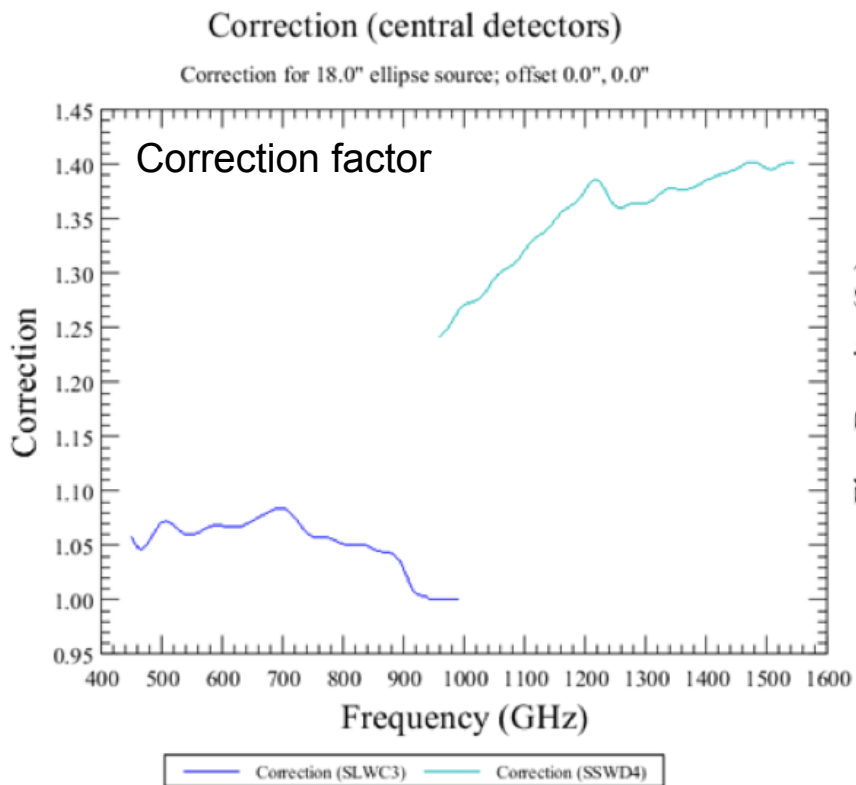





# Semi-extended Source Correction Tool

Some remarks on using this tool:

- Works best on bright objects.
- For faint objects, the continuum suffers an (additive) uncertainty on the order of 0.4 Jy. *It might be a good idea to try to reduce/remove this continuum offset using surrounding channels before applying the semi extended correction tool to your data.*
- For galaxies, it is likely that the warm CO lines come from a more compact region than the (cold) dust continuum. Thus, if your interest is in CO lines, it might be better not to apply this correction to your spectrum.



# V. Impact from Cooler Cycles

## SPIRE Thermal System

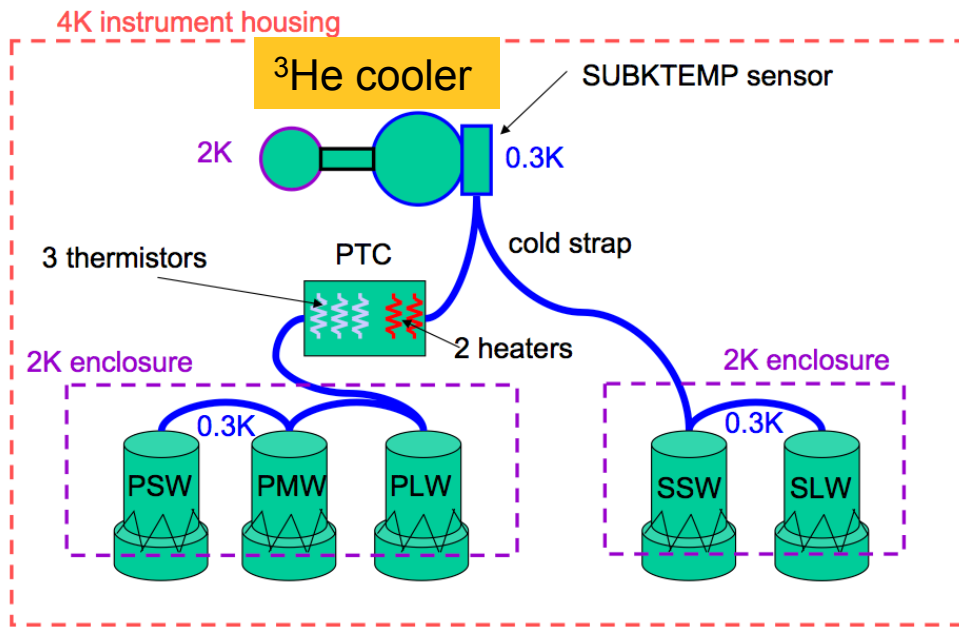

Fridge hold time ~ 45 hrs. n

## Subk Temperature

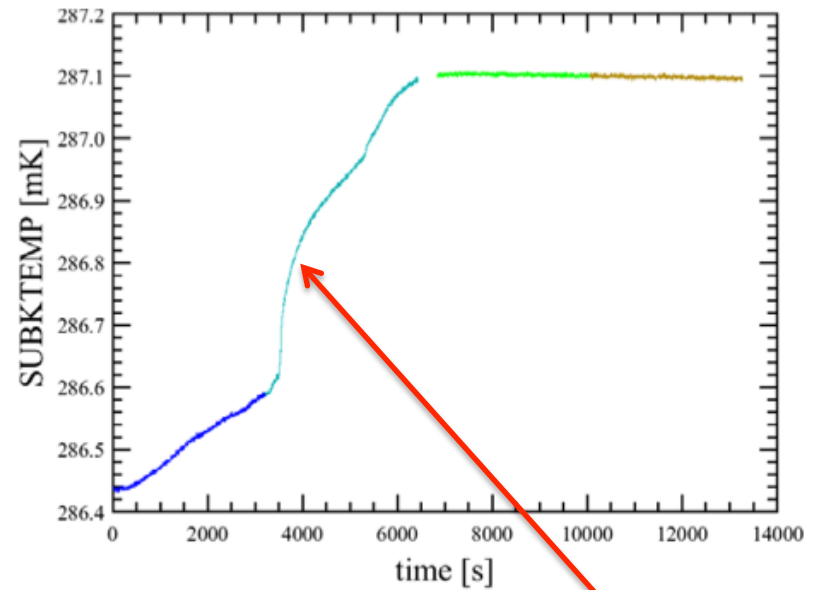

Unstable initial part  
("cooler burp")

## Impact from Cooler Cycles

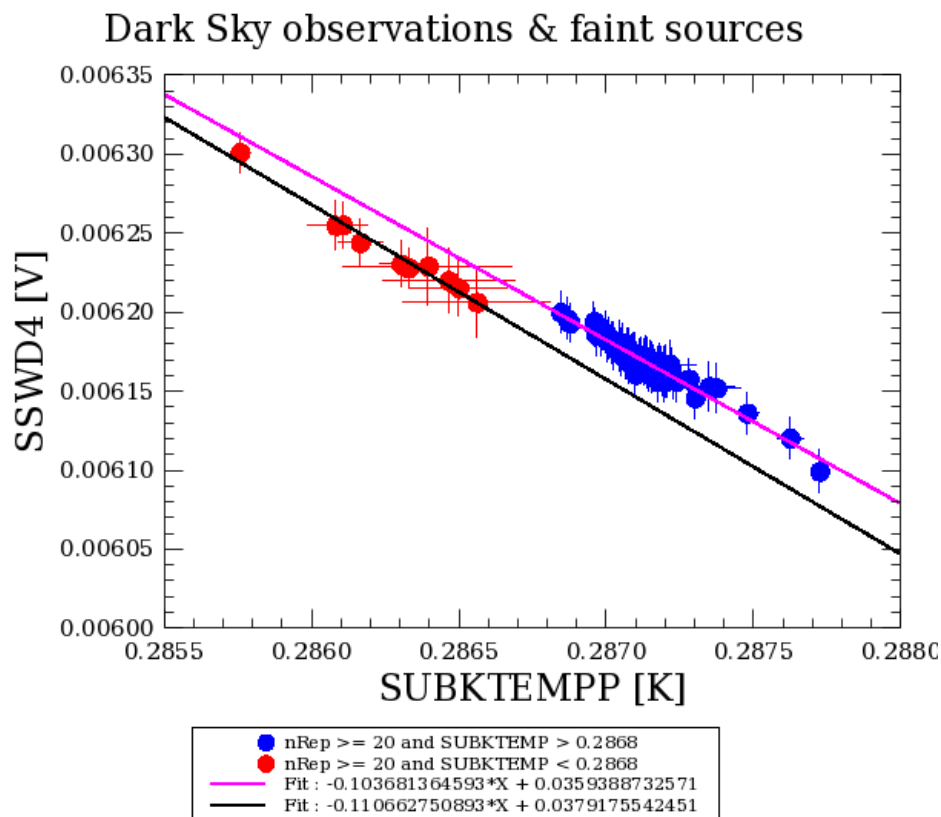

- Red data points are taken when SubK temp. still increases rapidly during the initial phase of a cooler cycle.
- If not corrected for, it leads to a flux over- (under-) estimate at the high (low) end of a spectrum.
- This can be empirically corrected. Investigation is still underway.



# VI. Caution on Low-resolution (LR) Data (with Long Integration)

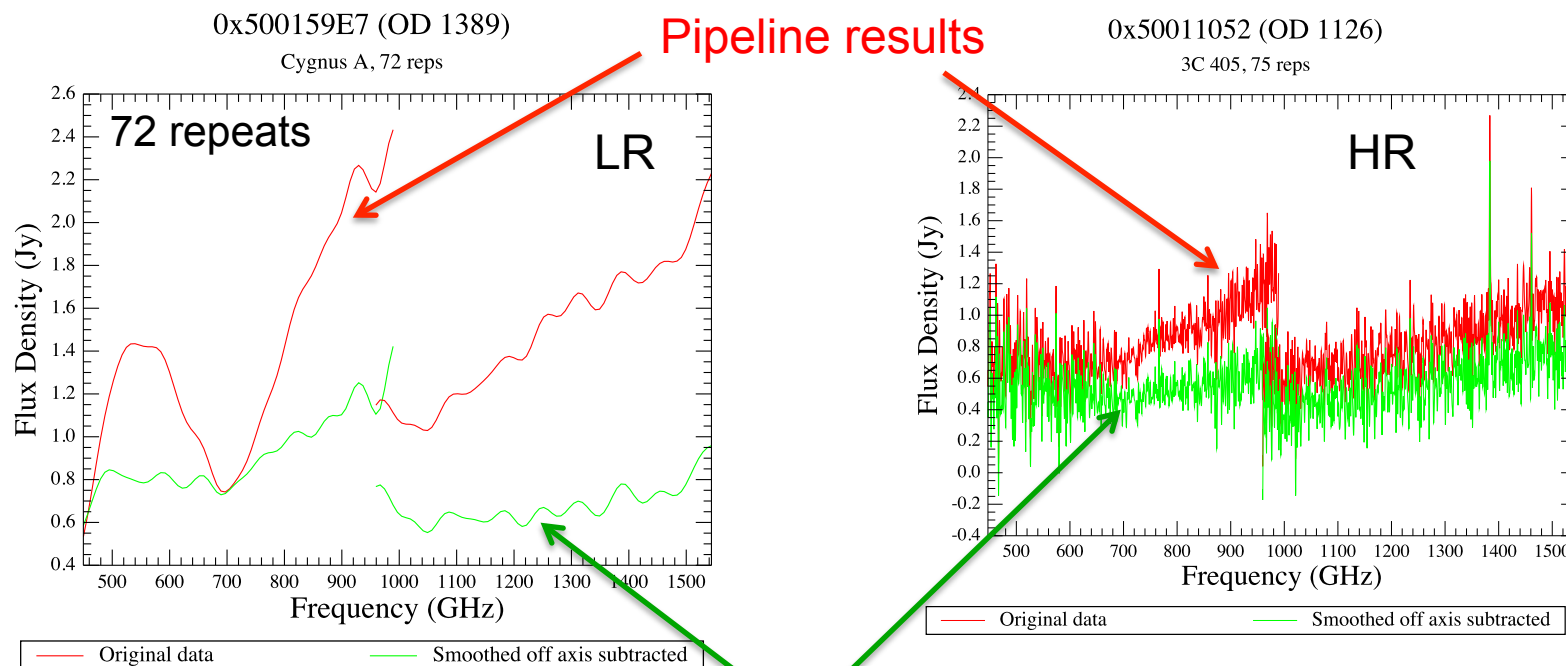

Results with further surrounding channel subtraction

Still under investigation!



# Summary on Potential Issues

## I. Continuum offset.

- Subtraction of a dark obs from the same observational day.
- Surrounding channel background subtraction.

## II. Fringes and how to remove them.

- Check HIPE 11 results first, for the least possible fringes.
- Subtraction of an HR dark from same day (available after OD1079)
- Noise template method (for ODs prior to OD1079 or any OD).

## III. Partially resolved lines.

- Gaussain-SINC profile fitting (but generally requiring a higher S/N).

## IV. Semi-extended sources (or pointing offset).

- Correction tool available. But be aware of the continuum uncertainty in faint sources and of the fact that lines may originate from a more compact region than the continuum.

## V. Impact from cooler cycles (under investigation).

## VI. Long exposures in the LR mode (under further investigation).



## Demo on Data Reprocessing

- I will use the script:
  - HIPE -> Pipelines -> SPIRE -> Spectrometer single pointing user pipeline.
- I will fetch the HIPE 10 results of the following observation from Herschel archive and reprocess it to HIPE 11:
  - Obsid = 1342230419
  - Target = ESO099-G004
  - HR, 40 FTS repeats, sparse sampling, with nominal detector setting.

(Note: This is one of the sample observations for the workshop.)
- We will let the script run during the coffee break. And we will come back in the last SPIRE session today compare the spectral noise between HIPE 10 and 11 results on this particular observation.